

### Technical Data of YBX3

电机型号	额定功率 kW	额定转速 r/min	额定电流 A	额定效率 $\eta$ %	功率因数 $\cos\Phi$	额定转矩 N.m	堵转电流 额定电流	堵转转矩 额定转矩	最大转矩 额定转矩	最小转矩 额定转矩	空载噪音 dB(A)	重量 kg
Motor Type	Rated Power kW	Rated Speed r/min	Rated Current A	Rated Eff. $\eta$ %	Power Factor $\cos\Phi$	Rated Torque Nm	$\frac{I_{st}}{I_n}$	$\frac{T_{st}}{T_n}$	$\frac{T_{max}}{T_n}$	$\frac{T_{min}}{T_n}$	LW dB(A) no load	Net Weight kg
2极 - 同步转速 3000r/min 2-pole, 3000r/min synchronous speed												
YBX3-80M1-2	0.75	2825	1.7	80.7	0.83	2.5	6.8	2.3	2.3	1.5	67	22
YBX3-80M2-2	1.1	2825	2.4	82.7	0.83	3.7	7.3	2.3	2.3	1.5	67	24
YBX3-90S-2	1.5	2840	3.2	84.2	0.84	5.0	7.6	2.3	2.3	1.5	72	33
YBX3-90L-2	2.2	2840	4.6	85.9	0.85	7.4	7.8	2.3	2.3	1.4	72	37
YBX3-100L-2	3	2880	6.0	87.1	0.87	10.0	8.1	2.3	2.3	1.4	76	48
YBX3-112M-2	4	2890	7.9	88.1	0.88	13.2	8.3	2.3	2.3	1.4	77	58
YBX3-132S1-2	5.5	2900	10.6	89.2	0.88	18.1	8.0	2.2	2.3	1.2	80	82
YBX3-132S2-2	7.5	2900	14.3	90.1	0.89	24.7	7.8	2.2	2.3	1.2	80	89
YBX3-160M1-2	11	2930	20.8	91.2	0.89	35.9	7.9	2.2	2.3	1.2	86	142
YBX3-160M2-2	15	2930	28.1	91.9	0.89	48.9	8.0	2.2	2.3	1.2	86	155
YBX3-160L-2	18.5	2930	34.2	92.4	0.89	60.3	8.1	2.2	2.3	1.1	86	178
YBX3-180M-2	22	2940	40.5	92.7	0.89	71.5	8.2	2.2	2.3	1.1	88	217
YBX3-200L1-2	30	2950	55.1	93.3	0.89	97.1	7.5	2.2	2.3	1.1	90	297
YBX3-200L2-2	37	2950	67.4	93.7	0.89	120	7.5	2.2	2.3	1.1	90	316
YBX3-225M-2	45	2970	81.7	94.0	0.89	145	7.6	2.2	2.3	1.0	90	363
YBX3-250M-2	55	2970	100	94.3	0.89	177	7.6	2.2	2.3	1.0	92	512
YBX3-280S-2	75	2970	135	94.7	0.89	241	6.9	2.0	2.3	0.9	94	667
YBX3-280M-2	90	2970	161	95.0	0.89	289	7.0	2.0	2.3	0.9	94	695
YBX3-315S-2	110	2980	195	95.2	0.89	353	7.1	1.9	2.2	0.9	96	939
YBX3-315M-2	132	2980	234	95.4	0.89	423	7.1	1.9	2.2	0.9	96	1024
YBX3-315L1-2	160	2980	280	95.6	0.89	513	7.1	1.9	2.2	0.9	98	1061
YBX3-315L-2	185	2980	323	95.8	0.89	513	7.1	1.9	2.2	0.9	98	1103
YBX3-315L2-2	200	2980	350	95.8	0.89	641	7.1	1.9	2.2	0.8	98	1155
YBX3-355M1-2	220	2980	385	95.8	0.89	705	7.1	1.8	2.2	0.8	100	1764
YBX3-355M2-2	250	2980	436	95.8	0.90	801	7.1	1.8	2.2	0.8	100	1819
YBX3-355L1-2	280	2980	488	95.8	0.90	897	7.1	1.8	2.2	0.8	100	1869
YBX3-355L2-2	315	2980	550	95.8	0.90	1009	7.1	1.8	2.2	0.8	100	1943
YBX3-3551-2	355	2980	624	95.0	0.90	1138	7.1	1.8	2.2	0.8	100	2111
YBX3-3552-2	400	2980	703	95.0	0.90	1282	7.1	1.8	2.2	0.8	100	2258

## Technical Data of YBX3

电机型号	额定功率 kW	额定转速 r/min	额定电流 A	额定效率 $\eta$ %	功率因数 $\cos\Phi$	额定转矩 N.m	堵转电流 额定电流	堵转转矩 额定转矩	最大转矩 额定转矩	最小转矩 额定转矩	空载噪音 dB(A)	重量 kg
Motor Type	Rated Power kW	Rated Speed r/min	Rated Current A	Rated Eff. $\eta$ %	Power Factor $\cos\Phi$	Rated Torque Nm	$\frac{I_{st}}{I_n}$	$\frac{T_{st}}{T_n}$	$\frac{T_{max}}{T_n}$	$\frac{T_{min}}{T_n}$	LW dB(A) no load	Net Weight kg
6 极 - 同步转速 1000r/min 6-pole, 1000r/min synchronous speed												
YBX3-80M1-6	0.37	910	1.3	62.0	0.70	3.9	4.7	1.9	2.0	1.5	54	24
YBX3-80M2-6	0.55	910	1.5	73.6	0.72	5.8	4.7	1.9	2.1	1.5	54	26
YBX3-90S-6	0.75	910	2.0	78.9	0.72	7.9	5.8	2.1	2.1	1.5	57	34
YBX3-90L-6	1.1	910	2.8	81.0	0.73	11.5	5.9	2.1	2.1	1.3	57	39
YBX3-100L-6	1.5	940	3.8	82.5	0.74	15.2	6.0	2.1	2.1	1.3	61	50
YBX3-112M-6	2.2	940	5.4	84.3	0.74	22.4	6.0	2.1	2.1	1.3	65	67
YBX3-132S-6	3	960	7.2	85.6	0.74	29.8	6.2	2.0	2.1	1.3	69	94
YBX3-132M1-6	4	960	9.5	86.8	0.74	39.8	6.8	2.0	2.1	1.3	69	102
YBX3-132M2-6	5.5	960	12.7	88.0	0.75	54.7	7.1	2.0	2.1	1.3	69	108
YBX3-160M-6	7.5	970	16.2	89.1	0.78	73.8	6.7	2.1	2.1	1.2	73	150
YBX3-160L-6	11	970	23.1	90.3	0.78	108	6.9	2.1	2.1	1.2	73	183
YBX3-180L-6	15	970	30.9	91.2	0.81	148	7.2	2.0	2.1	1.2	73	216
YBX3-200L1-6	18.5	970	37.8	91.7	0.81	182	7.2	2.1	2.1	1.2	76	292
YBX3-200L2-6	22	970	44.8	92.2	0.82	217	7.3	2.1	2.1	1.2	76	305
YBX3-225M-6	30	980	59.1	92.9	0.81	292	7.1	2.0	2.1	1.2	76	380
YBX3-250M-6	37	980	71.7	93.3	0.81	361	7.1	2.1	2.1	1.2	76	500
YBX3-280S-6	45	980	85.8	93.7	0.86	439	7.2	2.1	2.0	1.1	80	585
YBX3-280M-6	55	980	102	94.1	0.83	539	7.2	2.1	2.0	1.1	80	625

## Technical Data of YBX3

电机型号	额定功率	额定转速	额定电流	额定效率	功率因数	额定转矩	堵转电流	堵转转矩	最大转矩	最小转矩	绝缘等级	冷却方式
Motor Type	Rated Power kW	Rated Speed rpm	Rated Current A	Rated Eff. %	Power Factor cosφ	Rated Torque Nm	$I_{sc}$	$T_{sc}$	$T_{max}$	$T_{min}$	Insulation Class	Cooling Method

※

YBX3-355M2-8	160	740	315	94.0	0.82	2065	6.4	1.8	2.0	0.9	90	1885
YBX3-355L1-8	185	740	364	94.0	0.82	2388	6.4	1.8	2.0	0.9	90	2010
YBX3-355L2-8	200	740	389	94.2	0.83	2581	6.4	1.8	2.0	0.9	90	2078
YBX3-3551-8	220	740	425	94.8	0.83	2839	6.4	1.8	2.0	0.9	90	2112
YBX3-3552-8	250	740	483	94.8	0.83	3226	6.4	1.8	2.0	0.9	90	2158

## Technical Data of YBX3

电机型号	额定功率 kW	额定转速 r/min	额定电流 A	额定效率 $\eta$ %	功率因数 $\cos\Phi$	额定转矩 N.m	堵转电流 额定电流	堵转转矩 额定转矩	最大转矩 额定转矩	最小转矩 额定转矩	空载噪音 dB(A)	重量 kg
Motor Type	Rated Power kW	Rated Speed r/min	Rated Current A	Rated Eff. $\eta$ %	Power Factor $\cos\Phi$	Rated Torque Nm	$I_{st}/I_n$	$T_{st}/T_n$	$T_{max}/T_n$	$T_{min}/T_n$	LW dB(A) no load	Net Weight kg
10 极 – 同步转速 600r/min 10-pole, 600r/min synchronous speed												
YBX3-250M1-10	18.5	585	44.6	90.0	0.70	302	6.2	1.8	2.0	0.8	71	454
YBX3-250M2-10	22	585	53.1	90.0	0.70	359	6.2	1.8	2.0	0.8	71	478
YBX3-280S-10	30	585	67.2	90.5	0.75	490	6.2	1.6	2.0	0.8	73	534
YBX3-280M-10	37	585	82.8	90.5	0.75	604	6.2	1.6	2.0	0.8	75	602
YBX3-315S-10	45	587	100	91.2	0.75	732	6.2	1.3	2.0	0.8	82	835
YBX3-315M-10	55	587	122	91.8	0.75	895	6.2	1.3	2.0	0.8	82	925
YBX3-315L1-10	75	587	167	92.3	0.76	1220	6.2	1.3	2.0	0.8	82	996
YBX3-315L2-10	90	587	200	92.9	0.77	1464	6.2	1.3	2.0	0.8	82	1078
YBX3-355M1-10	110	587	230	93.1	0.78	1790	6.0	1.3	2.0	0.8	90	1556
YBX3-355M2-10	132	587	276	93.5	0.78	2148	6.0	1.3	2.0	0.8	90	1775

## MOUNTING AND DIMENSIONS

### Dimensions Foot Mount B3

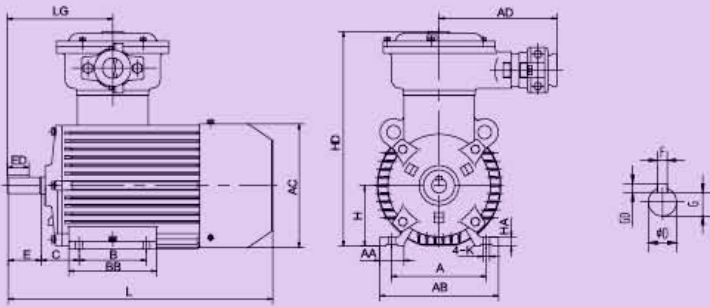

(YBX3-80-160)

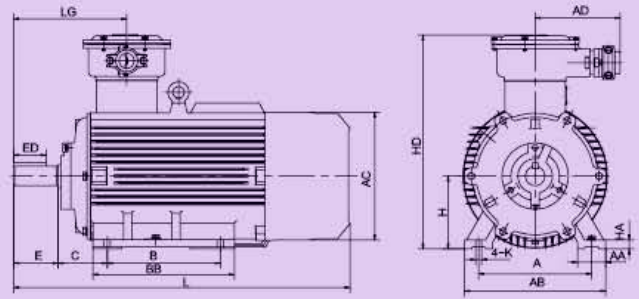

(YBX3-180-355)

FRAME	A	AA	AB	AC	AD	B	BB	C	D	E	ED	F	G	GD	H	HA	HD	K	L	LG
80M	125	34	160	180	175	100	130	50	19	40	22	6	15.5	6	80	10	296	10	318	141
90S	140	36	176	190	175	100	135	56	24	50	32	8	20	8	90	14	318	10	365	156
90L	140	36	176	190	175	125	160	56	24	50	32	8	20	8	90	14	318	10	390	156
100L	160	43	200	210	175	140	176	63	28	60	40	8	24	8	100	14	344	12	443	162
112M	190	50	240	225	190	140	180	70	28	60	40	8	24	8	112	16	369	12	492	183
132S	216	60	276	265	190	140	190	89	38	80	56	10	33	10	132	18	417	12	509	200
132M	216	60	276	265	190	178	230	89	38	80	56	10	33	10	132	18	417	12	559	200
160M	254	70	324	320	211	210	258	108	42	110	80	12	37	12	160	25	487	14.5	700	272
160L	254	70	324	320	211	254	310	108	42	110	80	12	37	12	160	25	487	14.5	730	272
180M	279	70	349	360	211	241	311	121	48	110	80	14	42.5	14	180	22	528	15	771	279
180L	279	70	349	360	211	279	349	121	48	110	80	14	42.5	14	180	22	528	15	791	279
200L	318	70	388	405	240	305	366	133	55	110	85	16	49	16	200	25	589	18	829	291
225S(4-8P)	356	75	431	450	240	286	355	149	60	140	100	18	53	18	225	28	634	19	845	346
225M(2P)	356	75	431	450	240	311	380	149	55	110	80	16	49	16	225	28	634	19	875	346
225M(4-8P)	356	75	431	450	240	311	380	149	60	140	100	18	53	18	225	28	634	19	875	346
250M(2P)	406	80	486	500	279	349	420	168	60	140	100	18	53	18	250	30	711	24	961	370
250M(4-8P)	406	80	486	500	279	349	420	168	65	140	100	18	58	18	250	30	711	24	961	370
280S(2P)	457	85	542	550	279	368	440	190	65	140	100	18	58	18	280	35	765	24	1020	378
280S(4-8P)	457	85	542	550	279	368	440	190	75	140	100	20	67.5	20	280	35	765	24	1020	378
280M(2P)	457	85	542	550	279	419	490	190	65	140	100	18	58	18	280	35	765	24	1080	378
280M(4-8P)	457	85	542	550	279	419	490	190	75	140	100	20	67.5	20	280	35	765	24	1080	378
315S(2P)	508	120	628	625	352	406	570	216	65	140	100	18	58	18	315	45	908	28	1250	472
315M(2P)	508	120	628	625	352	457	680	216	65	140	100	18	58	18	315	45	908	28	1370	472
315L(2P)	508	120	628	625	352	508	680	216	65	140	100	18	58	18	315	45	908	28	1370	472
315S(4-10P)	508	120	628	625	352	406	570	216	80	170	130	22	71	22	315	45	908	28	1280	472
315M(4-10P)	508	120	628	625	352	457	680	216	80	170	130	22	71	22	315	45	908	28	1400	472
315L(4-10P)	508	120	628	625	352	508	680	216	80	170	130	22	71	22	315	45	908	28	1400	472
355M(2P)	610	120	730	702	352	560	696	254	75	140	100	20	67.5	20	355	52	1040	28	1540	486
355L(2P)	610	120	730	702	352	630	766	254	75	140	100	20	67.5	20	355	52	1040	28	1650	486
355M(4-10P)	610	120	730	702	352	560	696	254	95	170	130	25	86	25	355	52	1040	28	1570	486
355L(4-10P)	610	120	730	702	352	630	766	254	95	170	130	25	86	25	355	52	1040	28	1680	486

## Dimension Foot and Flange Mount B35

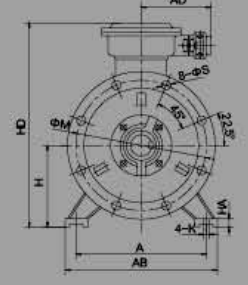
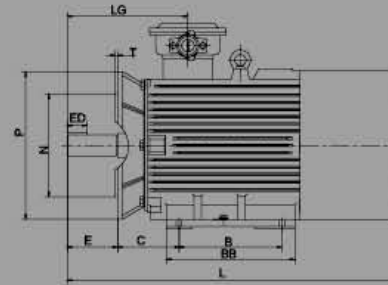
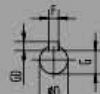
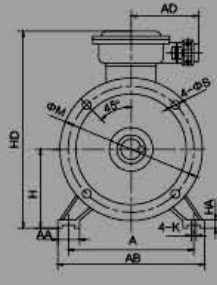
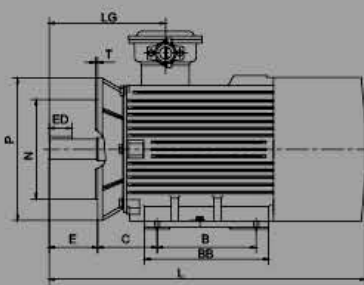

(YBX3-80-200)

(YBX3-225-355)

FRAME	A	AA	AB	AC	AD	B	BB	C	D	E	ED	F	G	GD	H	HA	HD	K	L	LG	M	N	P	S	T
80M	125	34	160	180	175	100	130	50	19	22	6	15.5	6	80	10	296	10	318	141	165	130	200	12	3.5	
90S	140	36	176	190	175	100	135	56	24	50	32	8	20	8	90	14	318	10	365	156	165	130	200	12	3.5
90L	140	36	176	190	175	125	160	56	24	50	32	8	20	8	90	14	318	10	390	156	165	130	200	12	3.5
100L	160	43	200	210	175	140	176	63	28	60	40	8	24	8	100	14	344	12	443	162	215	180	250	15	4
112M	190	50	240	225	190	140	180	70	28	60	40	8	24	8	112	16	369	12	492	183	215	180	250	15	4
132S	216	60	276	265	190	140	190	89	38	80	56	10	33	10	132	18	417	12	509	200	265	230	300	15	4
132M	216	60	276	265	190	178	230	89	38	80	56	10	33	10	132	18	417	12	559	200	265	230	300	15	4
160M	254	70	324	320	211	210	258	108	42	110	80	12	37	12	160	25	487	14.5	700	272	300	250	350	19	5
160L	254	70	324	320	211	254	310	108	42	110	80	12	37	12	160	25	487	14.5	730	272	300	250	350	19	5
180M	279	70	349	360	211	241	311	121	48	110	80	14	42.5	14	180	22	528	15	771	279	300	250	350	19	5
180L	279	70	349	360	211	279	349	121	48	110	80	14	42.5	14	180	22	528	15	791	279	300	250	350	19	5
200L	318	70	388	405	240	305	366	133	55	110	85	16	49	16	200	25	589	18	829	291	350	300	400	19	5
225M(2P)	356	75	431	450	240	311	380	149	55	110	80	16	49	16	225	28	634	19	875	346	400	350	450	19	5
225M(4-8P)	356	75	431	450	240	311	380	149	60	140	100	18	53	18	225	28	634	19	875	346	400	350	450	19	5
250M(2P)	406	80	486	500	279	349	420	168	60	140	100	18	53	18	250	30	711	24	961	370	500	450	550	19	5
250M(4-8P)	406	80	486	500	279	349	420	168	65	140	100	18	58	18	250	30	711	24	961	370	500	450	550	19	5
280S(2P)	457	85	542	550	279	368	440	190	65	140	100	18	58	18	280	35	765	24	1020	378	500	450	550	19	5
280S(4-8P)	457	85	542	550	279	368	440	190	75	140	100	20	67.5	20	280	35	765	24	1020	378	500	450	550	19	5
280M(2P)	457	85	542	550	279	419	490	190	65	140	100	18	58	18	280	35	765	24	1080	378	500	450	550	19	5
280M(4-8P)	457	85	542	550	279	419	490	190	75	140	100	20	67.5	20	280	35	765	24	1080	378	500	450	550	19	5
315S(2P)	508	120	628	625	352	406	570	216	65	140	100	18	58	18	315	45	908	28	1250	472	600	550	660	24	6
315M(2P)	508	120	628	625	352	457	680	216	65	140	100	18	58	18	315	45	908	28	1370	472	600	550	660	24	6
315L(2P)	508	120	628	625	352	508	680	216	65	140	100	18	58	18	315	45	908	28	1370	472	600	550	660	24	6
315S(4-10P)	508	120	628	625	352	406	570	216	80	170	130	22	71	22	315	45	908	28	1280	472	600	550	660	24	6
315M(4-10P)	508	120	628	625	352	457	680	216	80	170	130	22	71	22	315	45	908	28	1400	472	600	550	660	24	6
315L(4-10P)	508	120	628	625	352	508	680	216	80	170	130	22	71	22	315	45	908	28	1400	472	600	550	660	24	6





## Technical Data of YBX3

电机型号	额定功率 kW	额定转速 r/min	额定电流 A	额定效率 $\eta$ %	功率因数 $\cos \Phi$	额定转矩 N.m	堵转电流 额定电流	堵转转矩 额定转矩	最大转矩 额定转矩	最小转矩 额定转矩	空载噪音 dB(A)	重量 kg
Motor Type	Rated Power kW	Rated Speed r/min	Rated Current A	Rated Eff. $\eta$ %	Power Factor $\cos \Phi$	Rated Torque N.m	$I_{st}$ $I_n$	$T_{st}$ $T_n$	$T_{max}$ $T_n$	$T_{min}$ $T_n$	LW dB(A)	Net Weight kg